

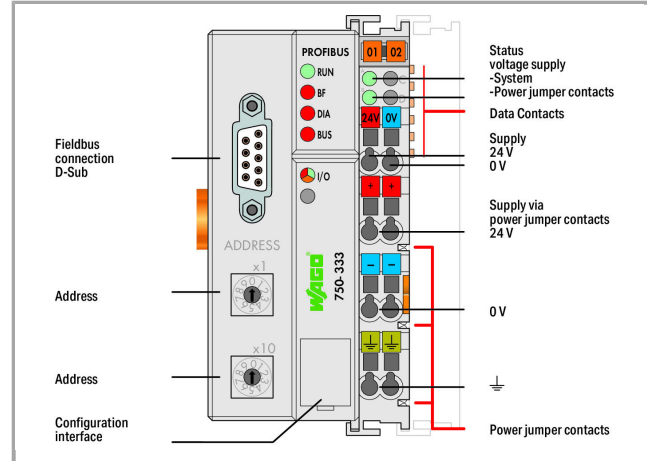

750-333/025-000

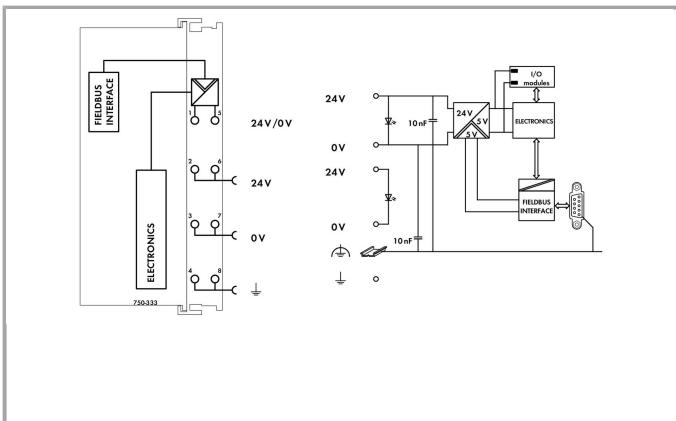

RoHS Compliant BOMcheck.net



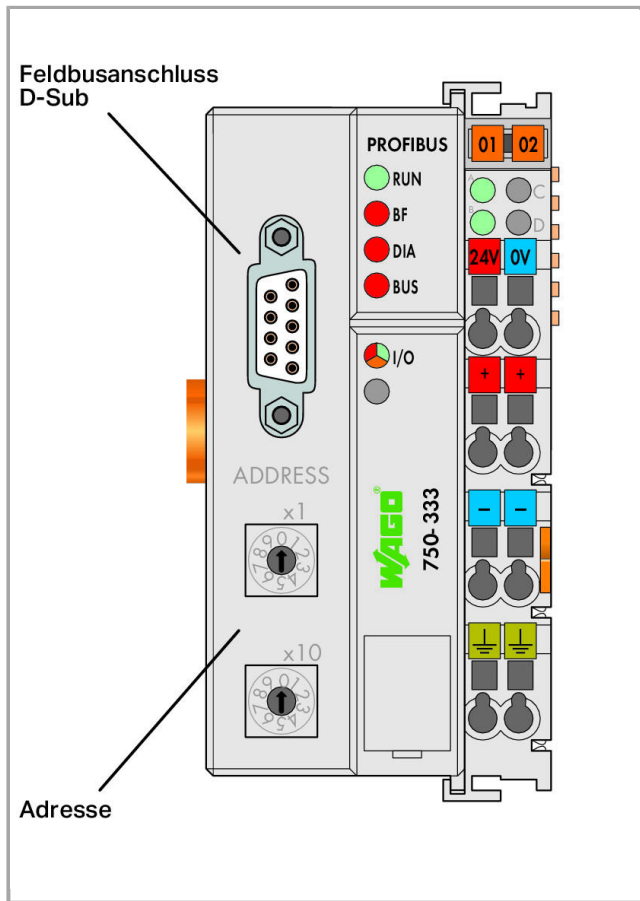

Item description

The 750-333 fieldbus coupler maps the peripheral data of all the I/O modules of the WAGO-I/O SYSTEM on PROFIBUS DP.

When initializing, the bus coupler determines the module structure of the node, to create the process image in Profibus. In order to optimize addresses, the I/O modules with a bit width smaller than 8 are grouped in one byte.

It is furthermore possible to deactivate I/O modules and to modify the image of the node according to the connected signals without having to modify the existing application.

The diagnostics concept is based on ID- and channel-related diagnosis according to EN 50170. This does away with the need for programming of modules for evaluating manufacturer-specific diagnostics data.

Note:

Note: GSD files required

Data

Technical Data

Communication	PROFIBUS
Number of fieldbus nodes on the master max.	96



Max. no. of I/O points	6000
Baud rate	9.6 kBd ... 12 MBd
Fieldbus segment length max.	1200 m
Transmission medium	Cu cable acc. to EN 50170
Transmission time	typ. 1 ms (10 couplers; 32 digital I/Os per coupler at 12 Mbaud) max. 3.3 ms
Number of modules per node max.	63
Input and output process image (Fieldbus) max.	244 Byte/244 Byte
System supply voltage	DC 24 V(-25 ... +30 %); via wiring level (CAGE CLAMP® connection)
Current consumption, system supply (5 V)	200 mA
Total current for system supply	1800 mA
System and sensor supply voltage)
Field supply voltage	DC 24 V (-25 ... +30 %); via power jumper contacts
Input current typ. at rated load (24 V)	500 mA
Efficiency of the power supply (typ.) at nominal load (24 V)	87 %
Isolation	500 V system/supply
Number of outgoing power jumper contacts	3
Current carrying capacity of the power jumper contacts	10 A

Connection data

Connection technology: communication/fieldbus	PROFIBUS: 1 x D-Sub 9 socket
Connection technology: field supply	6 x CAGE CLAMP®
Connection technology: system supply	2 x CAGE CLAMP®
Connection technology: Device configuration	1 x 4-pole male connector
Connection type (1)	System/field supply
Solid conductor	0.08 ... 2.5 mm ² / 28 ... 14 AWG
Fine-stranded conductor	0.08 ... 2.5 mm ² / 28 ... 14 AWG
Strip length	8 ... 9 mm / 0.31 ... 0.35 inch

Geometrical Data

Width	50.5 mm / 1.988 inch
Height	71.1 mm / 2.799 inch
Height from upper-edge of DIN-35 rail	63.9 mm / 2.516 inch
Depth	100 mm / 3.937 inch

Mechanical data

Type of mounting	DIN-35 rail
------------------	-------------



Material Data

Color	light gray
Housing material	Polycarbonate, polyamide 6.6
Fire load	1.756 MJ
Weight	183.811 g
Conformity marking	1

Environmental Requirements

Surrounding air (operating) temperature	-20 ... 60 °C
Surrounding air (storage) temperature	-40 ... 85 °C
Protection class	IP20
Degree of pollution (5)	2 per IEC 61131-2
Operating altitude	0 ... 2000 m
Mounting position	horizontal (standing/lying) or vertical
Relative air humidity (no condensation)	95 %
Relative humidity	Short-term condensation per Class 3K6/IEC EN 60721-3-3 and E DIN 40046-721-3, taking a temperature range of -20 ... +60 °C into consideration (except wind-driven precipitation, water and ice formation)
Vibration resistance	4g per IEC 60068-2-6
Shock resistance	15g per IEC 60068-2-27
EMC immunity to interference	acc. to EN 61000-6-2, marine applications
EMC emission of interference	acc. to EN 61000-6-4, marine applications
Exposure to pollutants	Per IEC 60068-2-42 and IEC 60068-2-43
Permissible H ₂ S contaminant concentration at a relative humidity 75 %	10 ppm
Permissible SO ₂ contaminant concentration at a relative humidity 75 %	25 ppm

Commercial data

Product Group	15 (Remote I/O)
Country of origin	DE
GTIN	4045454526887
Customs Tariff No.	85176200000

Approvals / Certificates

Ex-Approvals



Logo	Approval	Additional Approval Text	Certificate name
	ATEX	EN 60079-0	TÜV 07

	TUEV Nord Cert GmbH	ATEX 554086 X en.
--	---------------------	-------------------------



	TUEV Nord TUEV Nord Cert GmbH	IEC 60079-0	IECEX TUN 09.0001 X
--	----------------------------------	-------------	---------------------------

	UL Underwriters Laboratories Inc. (HAZARDOUS LOCATIONS)	ANSI/ISA 12.12.01	E198726 Sec.1
--	---	-------------------	------------------

Country specific Approvals

Logo	Approval	Additional Approval Text	Certificate name
	KC National Radio Research Agency	Article 58-2, Clause 3	MSIP- REM-W43- FBC750
	KC National Radio Research Agency	Article 58-2, Clause 3	MSIP- REM-W43- FBC750

Ship Approvals

Logo	Approval	Additional Approval Text	Certificate name
	ABS American Bureau of Shipping	-	19- HG1821812- PDA
	PRS Polski Rejestr Statków	-	TE/2214 /880590/18

UL-Approvals













Logo	Approval	Additional Approval Text	Certificate name
	UL UL International Netherlands B.V. (ORDINARY LOCATIONS)	UL 508	E175199 Sec.1

Compatible products

General accessories

	Item no.: 750-921 Bluetooth® Adapter	750-921
	Item no.: 750-923 Configuration cable; USB connector; Length: 2.5 m	750-923
	Item no.: 750-923/000-001 Configuration cable; USB connector; Length: 5 m	750-923 /000-001

Carrier rail

	Item no.: 210-112 Steel carrier rail; 35 x 7.5 mm; 1 mm thick; 2 m long; slotted; according to EN 60715; "Hole width 25 mm	210-112
	Item no.: 210-113 Steel carrier rail; 35 x 7.5 mm; 1 mm thick; 2 m long; unslotted; according to EN 60715	210-113
	Item no.: 210-114 Steel carrier rail; 35 x 15 mm; 1.5 mm thick; 2 m long; unslotted; similar to EN 60715	210-114
	Item no.: 210-115 Steel carrier rail; 35 x 7.5 mm; 1 mm thick; 2 m long; slotted; according to EN 60715; "Hole width 18 mm	210-115
	Item no.: 210-118 Steel carrier rail; 35 x 15 mm; 2.3 mm thick; 2 m long; unslotted; according to EN 60715	210-118
	Item no.: 210-196 Aluminum carrier rail; 35 x 8.2 mm; 1.6 mm thick; 2 m long; unslotted; similar to EN 60715	210-196
	Item no.: 210-197 Steel carrier rail; 35 x 15 mm; 1.5 mm thick; 2 m long; slotted; similar to EN 60715	210-197
	Item no.: 210-198 Copper carrier rail; 35 x 15 mm; 2.3 mm thick; 2 m long; unslotted; according to EN 60715	210-198
	Item no.: 210-504 Steel carrier rail; 35 x 7.5 mm; 1 mm thick; 2 m long; slotted; galvanized; according to EN 60715	210-504
	Item no.: 210-505 Steel carrier rail; 35 x 7.5 mm; 1 mm thick; 2 m long; unslotted; galvanized; according to EN 60715	210-505
	Item no.: 210-506 Steel carrier rail; 35 x 15 mm; 1.5 mm thick; 2 m long; unslotted; galvanized; similar to EN 60715	210-506
	Item no.: 210-508 Steel carrier rail; 35 x 15 mm; 1.5 mm thick; 2 m long; slotted; galvanized; similar to EN 60715	210-508















wiring and connectors

































Item no.: 750-960
Fieldbus Connector PROFIBUS; with D-sub male connector; 9-pole

750-960

Marking accessories

	Item no.: 2009-145 Mini-WSB Inline; for Smart Printer; on reel; stretchable 5 - 5.2 mm; plain; snap-on type	2009-145
	Item no.: 2009-145/000-002 Mini-WSB Inline; for Smart Printer; on reel; stretchable 5 - 5.2 mm; plain; snap-on type	2009-145 /000-002
	Item no.: 2009-145/000-005 Mini-WSB Inline; for Smart Printer; on reel; stretchable 5 - 5.2 mm; plain; snap-on type	2009-145 /000-005
	Item no.: 2009-145/000-006 Mini-WSB Inline; for Smart Printer; on reel; stretchable 5 - 5.2 mm; plain; snap-on type	2009-145 /000-006
	Item no.: 2009-145/000-007 Mini-WSB Inline; for Smart Printer; on reel; stretchable 5 - 5.2 mm; plain; snap-on type	2009-145 /000-007
	Item no.: 2009-145/000-012 Mini-WSB Inline; for Smart Printer; on reel; stretchable 5 - 5.2 mm; plain; snap-on type	2009-145 /000-012
	Item no.: 2009-145/000-023 Mini-WSB Inline; for smartPRINTER; on reel; stretchable 5 - 5.2 mm; plain; snap-on type	2009-145 /000-023
	Item no.: 2009-145/000-024 Mini-WSB Inline; for Smart Printer; on reel; stretchable 5 - 5.2 mm; plain; snap-on type	2009-145 /000-024
	Item no.: 248-501 Miniature WSB Quick marking system; plain; Marker width 5 mm; 10 strips with 10 markers per card	248-501
	Item no.: 248-501/000-002 Mini-WSB marking card; as card; not stretchable; plain; snap-on type	248-501 /000-002
	Item no.: 248-501/000-005 Mini-WSB marking card; as card; not stretchable; plain; snap-on type	248-501 /000-005
	Item no.: 248-501/000-006 Mini-WSB marking card; as card; not stretchable; plain; snap-on type	248-501 /000-006
	Item no.: 248-501/000-007 Mini-WSB marking card; as card; not stretchable; plain; snap-on type	248-501 /000-007
	Item no.: 248-501/000-012 Mini-WSB marking card; as card; not stretchable; plain; snap-on type	248-501 /000-012

	Item no.: 248-501/000-017 Mini-WSB marking card; as card; not stretchable; plain; snap-on type	7000-017	248-501
	Item no.: 248-501/000-023 Mini-WSB marking card; as card; not stretchable; plain; snap-on type	7000-023	248-501
	Item no.: 248-501/000-024 Mini-WSB marking card; as card; not stretchable; plain; snap-on type	7000-024	248-501
	Item no.: 750-100 Marker card; as a DIN A4 sheet; plain		750-100
	Item no.: 750-103 Group marker carrier		750-103
	Item no.: 750-106 Group marker carrier		750-106
shield connection			
	Item no.: 790-108 Shield clamping saddle; 11 mm wide; diameter of compatible conductor		790-108
	Item no.: 790-116 Shield clamping saddle; 19 mm wide; diameter of compatible conductor; 7 ... 16 mm		790-116
	Item no.: 790-124 Shield clamping saddle; 27 mm wide; diameter of compatible conductor; 6 ... 24 mm		790-124
	Item no.: 790-140 Shield clamping saddle; diameter of compatible conductor		790-140
	Item no.: 790-208 Shield clamping saddle; 12.4 mm wide; 3 ... 8 mm		790-208
	Item no.: 790-216 Shield clamping saddle; 21.8 mm wide; 6 ... 16 mm		790-216
	Item no.: 790-220 Shield clamping saddle; 30 mm wide; 6 ... 20 mm		790-220
system box			
	Item no.: 850-804 IP65 enclosure; Stainless steel; WxHxD (400x123x200 mm); 4 x M20, 16 x M16, 28 x M12 cable grip		850-804
	Item no.: 850-804/000-001 IP65 enclosure; Stainless steel; WxHxD (400x123x200 mm); 2 x M20, 13 x M16, 32 x M12 cable grip	7000-001	850-804
	Item no.: 850-805 IP65 enclosure; Stainless steel; WxHxD (600x123x200 mm); 4 x M20, 19 x M16, 67 x M12 cable grip		850-805
	Item no.: 850-814/002-000 IP65 enclosure; Sheet steel (RAL 7035); WxHxD (200x120x200 mm); without flange plate	7002-000	850-814

	Item no.: 850-815/002-000 IP65 enclosure; Sheet steel (RAL 7035); WxHxD (300x120x200 mm); without flange plate	850-815
		7002-000
	Item no.: 850-816/002-000 IP65 enclosure; Sheet steel (RAL 7035); WxHxD (400x120x200 mm); without flange plate	850-816
		7002-000
	Item no.: 850-817/002-000 IP65 enclosure; Sheet steel (RAL 7035); WxHxD (600x120x200 mm); without flange plate	850-817
		7002-000
	Item no.: 850-825 IP65 enclosure; Aluminium (RAL 7032); WxHxD (160x100x160 mm); 9 x M12, 4 x M20	850-825
	Item no.: 850-826 IP65 enclosure; Aluminium (RAL 7032); WxHxD (240x100x160 mm); 4 x M20, 4 x M16, 14 x M12 cable grip	850-826
	Item no.: 850-826/002-000 IP65 enclosure; Aluminium (RAL 7035); WxHxD (240x100x160 mm); 4 x M20, 4 x M16, 14 x M12 cable grip	850-826
		7002-000
	Item no.: 850-827 IP65 enclosure; Aluminium (RAL 7032); WxHxD (320x100x160 mm); 4 x M20, 8 x M16, 17 x M12 cable grip	850-827
	Item no.: 850-827/002-000 IP65 enclosure; Aluminium (RAL 7035); WxHxD (320x100x160 mm); 4 x M20, 8 x M16, 17 x M12 cable grip	850-827
		7002-000
	Item no.: 850-828 IP65 enclosure; Aluminium (RAL 7032); WxHxD (480x100x160 mm); 4 x M20, 10 x M16, 35 x M12 cable grip	850-828
	Item no.: 850-828/002-000 IP65 enclosure; Aluminium (RAL 7035); WxHxD (480x100x160 mm); 4 x M20, 10 x M16, 35 x M12 cable grip	850-828
		7002-000
	Item no.: 850-834 IP65 enclosure; Polyester (RAL 7032); WxHxD (164x100x164 mm); 9 x M12, 4 x M20	850-834
	Item no.: 850-835 IP65 enclosure; Polyester (RAL 7032); WxHxD (244x100x164 mm); 4 x M20, 4 x M16, 14 x M12 cable grip	850-835
	Item no.: 850-836 IP65 enclosure; Polyester (RAL 7032); WxHxD (324x100x164 mm); 4 x M20, 8 x M16, 17 x M12 cable grip	850-836

Downloads

Documentation

Manual

PROFIBUS DP/ V1 Fieldbus Coupler EN 50170, 12 MBaud, digital and analog signals	V 1.2.0	pdf 7.6 MB	Download
--	---------	---------------	----------

Bid Text



750-333/025-000 IO, Koppler	Oct 2, 2014	doc 29.2 kB	Download
--------------------------------	-------------	----------------	----------

Additional Information

Disposal; Electrical and electronic equipment, Packaging	V 1.0.0	pdf 265.8 kB	Download
--	---------	-----------------	----------

System Description

Overview on WAGO-I/O-SYSTEM 750 approvals		pdf 780.2 kB	Download
---	--	-----------------	----------

Use in Hazardous Environments Term definition, marking and installation regulations	V 1.0.0	pdf 1.0 MB	Download
--	---------	---------------	----------

750/753 Series I/O-System – General Product Information		pdf 1.7 MB	Download
---	--	---------------	----------

Design Notes Basic conditions and recommendations for higher operational safety	V 2.0.0	pdf 1.5 MB	Download
--	---------	---------------	----------

Application Notes

Application Note CoDeSys 2.3

HART-Tool-Routing über PROFIBUS mit 750-833 und 750-333 (a116140) Der Anwendungshinweis beschreibt die Einrichtung von Asset-Management-Systemen, welche das einfache, effiziente und schnelle Konfigurieren von HART-Feldgeräten ermöglichen. Am Beispiel des Cerabar PMC51 (Endress+Hauser) erfolgt die Anbindung des HART-Sensors an den WAGO-PROFIBUS-Controller (750-833) bzw. WAGO-PROFIBUS-Koppler (750-333). Der zyklische PROFIBUS-Master (750-8208) koordiniert den Profibus-Feldbus. Über den TH LINK PROFIBUS (azyklischer Profibus Master) können die Asset-Management-Anwendungen (WAGOframe, PACTware und FieldCare) azyklisch über das HART-Modul (750-482 bzw. 750-484) auf die HART-Feldgeräte zugreifen.	1.0.0 Mar 22, 2019	pdf 5.3 MB	Download
--	-----------------------	---------------	----------

Runtime Software

Firmware

Firmware: 750-333/025-000 Fieldbus Coupler PROFIBUS DP; 2nd Generation; 12 MBd; Ext. Temperature	20 Mar 28, 2019	zip 499.2 kB	Download
--	--------------------	-----------------	----------

CAD/CAE - Smart Data

CAD data

3D Download 750-333/025-000



[URL](#) [Download](#)

Device Files

Device Description File

750-910; GSD files for PROFIBUS / 750, 752, 755, 758 and 767 Series	6.3 Jun 15, 2017	zip 4.7 MB	Download
EDD file for SIMATIC PDM for 750-333, 750-833, 750-482, 750-484	1.0 Nov 22, 2010	zip 185.2 kB	Download

Device Driver

WAGO USB Service Cable Driver / 750 and 857 Series 759-923	6.5.3.0 Sep 10, 2014	zip 4.8 MB	Download
---	-------------------------	---------------	--------------------------

Product family

750/753 Series I/O-System
[Learn more about the product family.](#)

[Show all products from the family](#)

Subject to changes.